

Ławka BERLIN kod 0111



Materiały:
Beton zbrojony kl. B-30
Drewno impregnowane, lakierobejca

Wymiary:
Wysokosc 76cm
Szerokosc 70cm
Długosc 180cm
Waga 125kg

Montaż:
Do zabetonowania

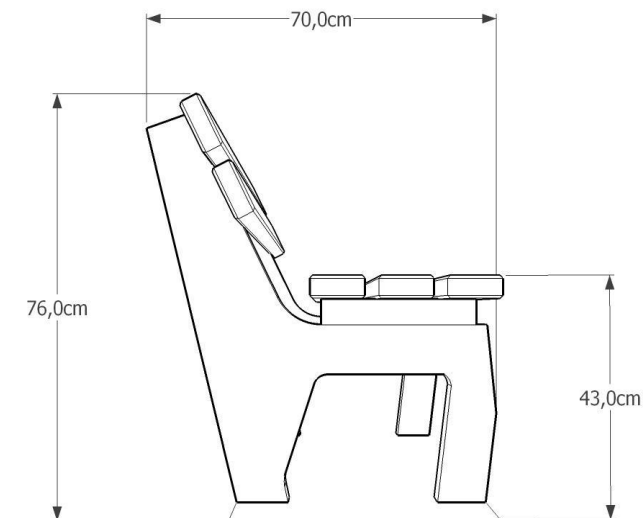

Inne produkty tej serii:

Ławka Berlin kod 0112

